

AD3-80MBIC



- Three Phase Four Wire kWh Meter (Import & Export) 230/400 Volt - 50 Hz - 80 Amp
- MID Certified Appendix "B" and "D"
- RS-485 Modbus Protocol (Autometers V.6)
- 2-Rate register (requires external time switch)

WARNING
The Autometers range of DIN rail mounted meters should only be installed by a competent and qualified electrician who is fully aware of the latest electricity regulations concerning the installation of Electricity meters. The AD3-80MBIC must be installed in a suitable enclosure.

Main Menu

Device Switch ON

Main Page: When the meter has been installed and power has been applied the meter register will default to Active energy, according to the tariff and type of load you are monitoring (Import or Export). In most cases it will default to Active energy, Import, tariff 1. (illustration below)

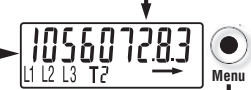

Second Active Energy Page

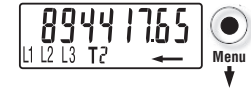

Third Active Energy Page

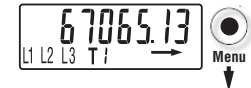

Fourth Energy Page: In the second, third and fourth pages are represented the other 3 energy registers

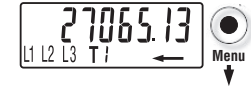

Modbus Address Page: In this page the Modbus address appears. You can modify its value between 1 and 247. See the section editable value.

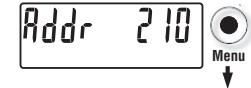

Modbus Baudrate Page: In this page the Modbus baud rate appears. you can choose among 1200, 2400, 4800, 9600 and 19200 bits per second. See the section editable value.



Firmware Release Page: You can read the index of firmware release.



Firmware CheckSum Page: The checksum is periodically calculated to verify that the firmware is reliable.

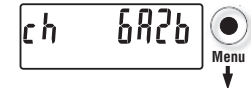

Display Test Page: All the display segments are visible. Whichever the page on the display, if no key is pushed for at least 20 sec., the main page appears again.



Partial counter

Partial Active Energy Counters: By pushing the "Partial key" partial active energy counters are readable in the main, second, third and fourth pages (i.e. for monthly energy consumption).



These counters are resettable. By keeping the "Menu key" pushed for 4 sec., "Reset" appears on the display. The key must be released. To do the reset, push shortly the "Menu key" again. By pushing the "Partial key" in any of the four pages, you go back to the Main menu

Diagnostic Messages

One or more missing phase: In case one or more phase is not detected, the corresponding icon disappears from the bottom row of the display. E.G. L2 is not detected.

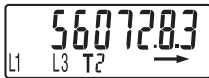

Phase sequence error: When the three phases are not in the correct zero-crossing sequence this message appears and the icons L1 and L2 blink. To make this message to disappears, you can keep pushed the "Menu key" for at least 4 seconds.



Error condition: When the display shows the message "ErrDr 01", the meter has got a malfunction and must be replaced.

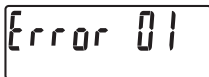

Display

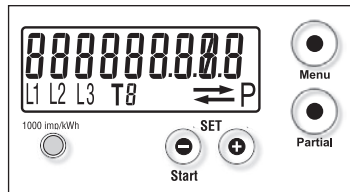

- Energy value
- Energy export (absorbed ←)
- Energy import (supplied →)
- Eingabe der Parameter
- Parameters set

- Tarif Running tariff, called tariff
- Energy line (L1-2-3)
- Energy value "Partial"
- Precision control LED
- Command button for "partial" reading selection
- Menu key for reading selection

Adjusting the Modbus address and Baudrate

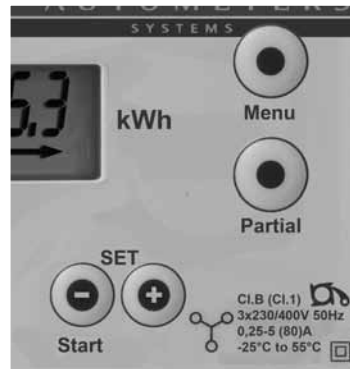

- 1) Press the "Menu" key until "Addr 001" appears on the display
 - 2) Press and hold down the "-" key for 4 sec. and release
 - 3) You will notice "001" blinking
 - 4) Press the "+" key to increment the number.
 - 5) To lock the number press and hold down the "Menu" key for 4 seconds. The Modbus address has now been set.
- To alter the Baudrate: Press the "Menu" key until "br 9600" appears and repeat above steps 2-5.

Dimension

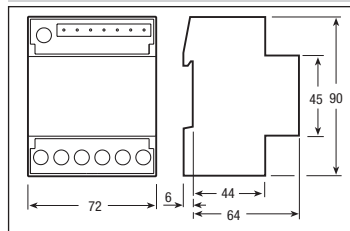

Sealable terminal covers

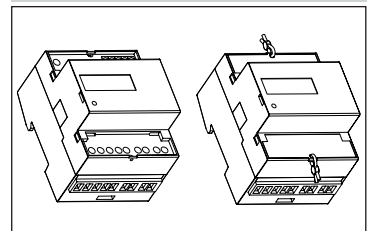

MID calibrated

- Device code and certification data indications
- Safety-sealing between upper and lower housing part

Cable stripping length and max. terminal screw torque

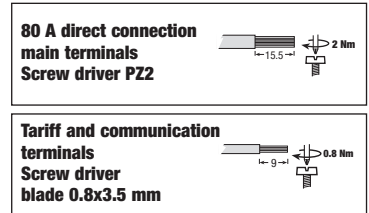

Wiring diagram

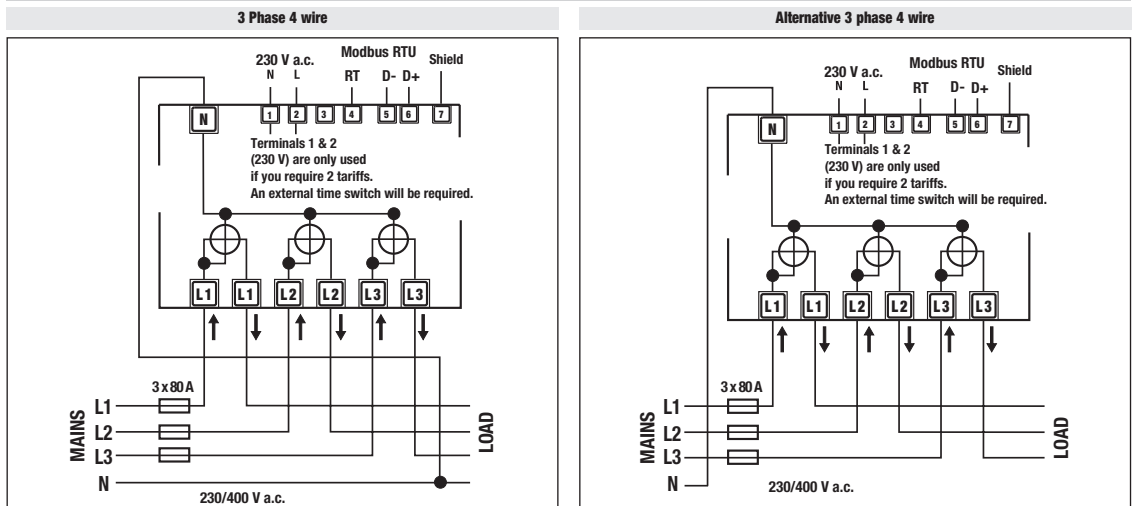

(N) Neutral wire must be connected the meter

Technical data

Data in compliance with EN 50470-1, EN 50470-3			AD3-80BIC Direct 80 A
General characteristics			
• Housing	DIN 43880	DIN	4 modules
• Mounting	EN 60715	35 mm	DIN rail
• Depth		mm	70
Operating features			
• Connectivity	to three-phase network	n° wires	4
• Storage of energy values and configuration	digital display (EEPROM)	-	yes
• Display tariffs identifier	for active energy	n° 2	T1 and T2
Supply			
• Rated control supply voltage <i>Un</i>		V a.c.	230
• Operating range voltage		V	184 ... 276
• Rated frequency <i>fn</i>		Hz	50
• Rated power dissipation (max. for phase) <i>Pv</i>		VA (W)	≤8 (0.6)
Overload capability			
• Voltage <i>Un</i>	continuous: phase/phase	V	480
	1 second: phase/phase	V	800
	continuous: phase/N	V	276
	1 second: phase/N	V	300
• Current <i>I_{max}</i>	continuous	A	80
	momentary (0,5 s)	A	-
	momentary (10 ms)	A	2400
Display (readouts)			
• Connection errors and phase out	discernible from phase-sequence indic.	-	PHASE Err
• Display type	LCD	n° digits	9 (2 decimals)
	digit dimensions	mm x mm	6.00 x 3
• Active energy: 1 display, 9 digit - 2 tariffs + display import or export (arrow)	min. measuring energy	kWh	0.01
	max. measuring overflow	kWh	9999999.99
• Instantaneous tariff measurement	1 display, 1-digit	-	T1 or T2
• Display period refresh		s	1
Measuring accuracy			
• Active energy and power	acc.to EN 50470-3	class	B
Measuring input			
• Type of connection		-	direct
• Voltage <i>Un</i>	phase/phase	V	400
	phase/N	V	230
• Operating range voltage	phase/phase	V	319 ... 480
	phase/N	V	184 ... 276
• Current <i>I_{ref}</i>		A	5
• Current <i>I_n</i>		A	-
• Current <i>I_{min}</i>		A	0.25
• Operating range current (<i>I_{st} ... I_{max}</i>)	direct connection	A	0.015 ... 80
• Frequency		Hz	50
• Input waveform		-	sinusoidal
• Starting current for energy measurement (<i>I_{st}</i>)		mA	15
Optical interfaces			
• Front side (<i>accuracy control</i>)	LED	imp/kWh	1000
Safety acc. to EN 50470-1			
• Indoor meter		-	yes
• Degree of pollution		-	2
• Operational voltage		V	300
• AC voltage test (EN 50470-3, 7.2)		kV	4
• Impulse voltage test		1.2/50 µs-kV	6
• Protection class (EN 50470)		class	II
• Housing material flame resistance	UL 94	class	V0
• Safety-sealing between upper and lower housing part		-	yes
Embedded communication			
• Modbus RTU	RS-485 - 3 wires	-	up to 19.200 bps
Connection terminals			
• Type cage main current paths	screw head Z +/-	POZIDRIV	PZ2
• Type cage pulse output	blade for slotted screw	mm	0.8 x 3.5
• Terminal capacity main current paths	solid wire min. (max.)	mm ²	1.5 (35)
	stranded wire with sleeve min. (max.)	mm ²	1.5 (35)
• Terminal capacity pulse output	solid wire min. (max.)	mm ²	1 (4)
	stranded wire with sleeve min. (max.)	mm ²	1 (2.5)
Environmental conditions			
• Mechanical environment		-	M1
• Electromagnetic environment		-	E2
• Operating temperature		°C	-25 ... +55
• Limit temperature of transportation and storage		°C	-25 ... +70
• Relative humidity (not condensation)		%	≤80
• Vibrations	50 Hz sinusoidal vibration amplitude	mm	±0.075
• Degree protection	housing when mounted in front (term.)	-	IP51(*)/IP20

(*) For the installation in a cabinet at least with IP51 protection.